

Gewährleistung erlischt bei Beschädigung!

Warranty void if broken!

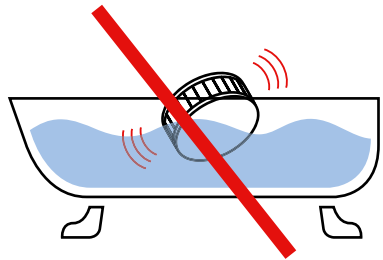

Das Gerät nicht ins Wasser tauchen!

Do not immerse the system in water!

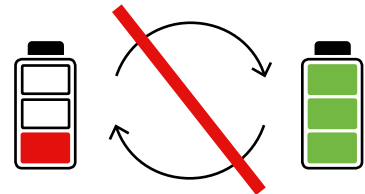

Batteriewechsel nicht möglich
No battery exchange

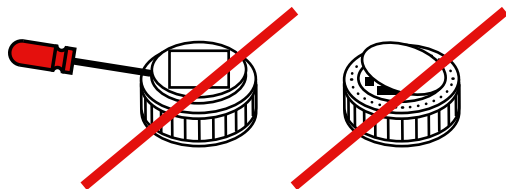

Geschlossenes System, nur Deckel kann gewechselt werden
Closed system, only cover is changeable

Das Gerät ausschalten

How to Deactivate the system

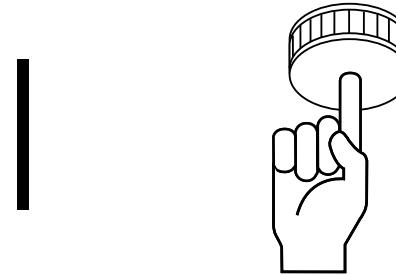

Auf Deckel drücken, um das Signal stumm zu schalten
Push cover to turn the signal off

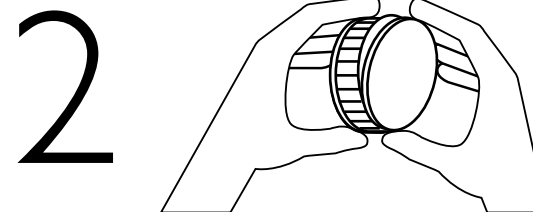

Deckel abnehmen
Open the cover

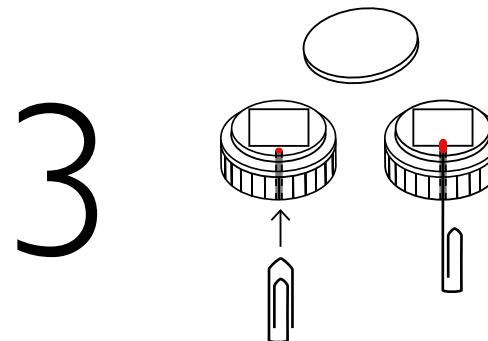

Roten Knopf herausdrücken, um Gerät auszuschalten
Push red button to power off

Signale
Signals

Lautstärke
Volume

Ursache
Cause

Signal aus
Signal Off

Wieder nach
Repeated after

Jede Sekunde erfolgt ein zweifacher Ton (kurz: Piep, lang: Piep).
Every second a double tone is emitted (short: beep, long: beep).

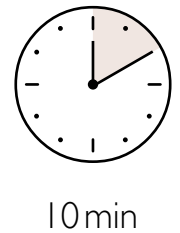
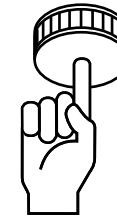
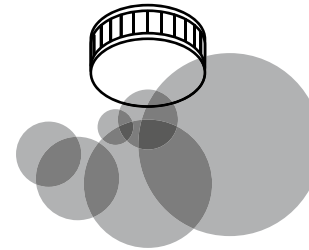

Alle 90 Sekunden erfolgt ein einfacher Ton (kurz: Piep).
Every 90 seconds a simple tone is emitted (short: beep).

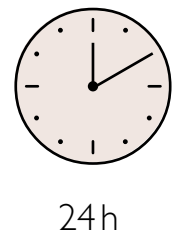
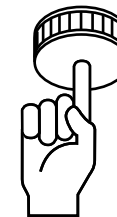

Alle 90 Sekunden erfolgt ein zweifacher Ton (kurz: Piep, kurz: Piep).
Every 90 seconds, there is a double tone (short: beep, short: beep).

